

COMMERCIAL MANUAL SCREEN PRINTERS

**Wrench Free
Micro-registration**

V-1000



V1-88
8 table, 8 color shown
Standard size 15" x 17"
(38 x 43 cm) steel pallets

The V-1000 press uses the industry's most unique floating head design which minimizes cost. Accurate registration is achieved without the higher price associated with machines of this capacity.

- Options**
- Utility cart for storage and mobility
 - HD Head upgrade
 - Drop-down wheel set
 - Service pan and wheel set
 - Youth, oversized*, sleeve, hat, pocket, and polo shirt pallets

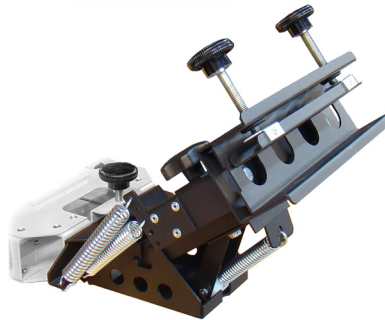

HD Head upgrade now available so you can use larger screens and pallets, and The DiGiT numbering attachment!

V-1000 features

- VALUE** Quality at an entry level price
- LONG LASTING** Steel Pallets w/ rubber tops - interchangeable with the V-2000**
- ACCURATE** Wrench free micro-registration
- PRECISE** Holds accurate multicolor printing registration
- INNOVATIVE** Floating Head, 3 point bearing lock allows multiple heads down
- ADJUSTABLE** 6 way head leveling adjustment
- VERSATILE** Available up to 8 table, 8 color (8x8)
- CAPACITY** Holds up to 21" x 28" (51 x 61 cm) screens
- GUARANTEED** 3 year warranty on manufacturer's defects
- SHIPS UPS** Can even ship UPS in multiple boxes
- EXPANDABLE** From 1 table, 1 color (1x1) to 8 table, 8 color (8x8)

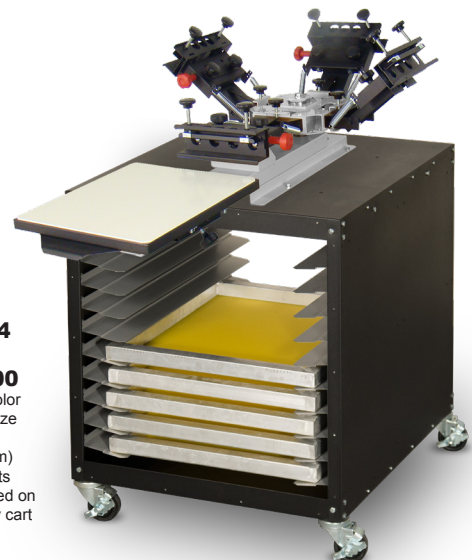

**V1-T14
+
UC-1000**
1 table, 4 color
Standard size
15" x 17"
(38 x 43 cm)
steel pallets
shown mounted on
optional utility cart

*The largest pallet available is the oversized 17" x 21" (43 x 53 cm).



V-1000 MODEL GALLERY



V-188
8 Station/8 Color

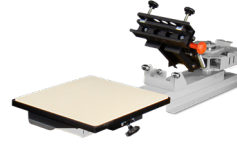

V-T11
1 Station/1 Color

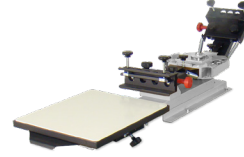

V-T12
1 Station/2 Color

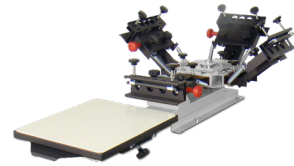

V-T14
1 Station/4 Color

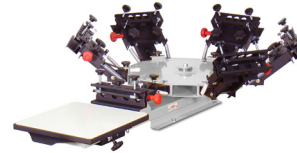

V-T16
1 Station/6 Color

ACCESSORIES

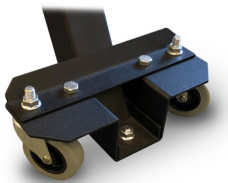

WS-VIDD
Drop Down Wheel
Set for V-1000



V-44
4 Station/4 Color

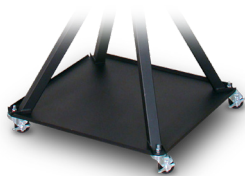

VISP-WS
Service Pan and Wheel
Set for V-1000



V-46
4 Station/6 Color

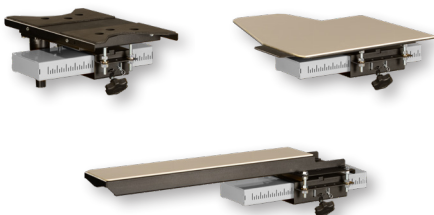

PALLETS
Over 100 different
pallets to choose from!



V-66
6 Station/6 Color



V-100 & V-1000

Technical Specifications



	V-100 Series		V-1000 Series					
	V100-11	V100-44	V1-T11	V1-T14	V1-44	V1-46	V1-66	V1-88
Warranty	1 Year	1 Year	3 year	3 year	3 year	3 year	3 year	3 year
Pallet Materials	Steel	Steel	Steel w/ rubber tops	Steel w/ rubber tops	Steel w/ rubber tops	Steel w/ rubber tops	Steel w/ rubber tops	Steel w/ rubber tops
Head Lifting Spring	Extension Spring	Extension Spring	Extension Spring	Extension Spring	Extension Spring	Extension Spring	Extension Spring	Extension Spring
All Heads Down via	Floating Heads	Floating Heads	Floating Heads	Floating Heads	Floating Heads	Floating Heads	Floating Heads	Floating Heads
Micro-registration	N/A	N/A	Wrenchless	Wrenchless	Wrenchless	Wrenchless	Wrenchless	Wrenchless
Leveling	Basic	Basic	Basic	Basic	Basic	Basic	Basic	Basic
Height legs to pallet	N/A	N/A	N/A	N/A	34.5" (88 cm)	34.5" (88 cm)	34.5" (88 cm)	34.5" (88 cm)
Height legs (w-wheels) to pallet	N/A	N/A	N/A	N/A	38.5" (98 cm)	38.5" (98 cm)	38.5" (98 cm)	38.5" (98 cm)
Diameter (Standard)	49" (125 cm)	71" (181 cm)	48" (122 cm)	75" (191 cm)	83" (211 cm)	94" (239 cm)	94" (239 cm)	102" (259 cm)
Diameter (Fully Extended)	56" (143 cm)	68" (219 cm)	55" (140 cm)	83" (211 cm)	95" (241 cm)	106" (269 cm)	110" (280 cm)	118" (300 cm)
Maximum Screen Width***	23" (58 cm)	21" (53 cm)	25" (63.5 cm)	25" (63.5 cm)	25" (63.5 cm)	21" (53 cm)	21" (53 cm)	21" (53 cm)
Maximum Screen Width w/ optional side clamps	N/A	N/A	N/A	N/A	N/A	N/A	N/A	N/A
Max. Screen Weight	5.5 lbs (2.5 kg)	5.5 lbs (2.5 kg)	5.5 lbs (2.5 kg)	5.5 lbs (2.5 kg)	5.5 lbs (2.5 kg)	5.5 lbs (2.5 kg)	5.5 lbs (2.5 kg)	5.5 lbs (2.5 kg)
Max. Screen Weight w/ HD Head upgrades	N/A	N/A	26 lbs (11.8 kg)	26 lbs (11.8 kg)	26 lbs (11.8 kg)	26 lbs (11.8kg)	26 lbs (11.8kg)	26 lbs (11.8kg)
Maximum Standard Pallet size	16" x 20" (41 x 51 cm)	16" x 20" (41 x 51 cm)	20" x 24" (51 x 61 cm)	20" x 24" (51 x 61 cm)	20" x 24" (51 x 61 cm)	20" x 24" (51 x 61 cm)	20" x 24" (51 x 61 cm)	20" x 24" (51 x 61 cm)
Fits Through 33" (84 cm) Doorway	Yes	Yes	Yes	Yes	Yes	Yes	Yes	Yes
Unit Weight	67 lbs (30.4 kg)	120 lbs (54.5 kg)	54 lbs (24.5 kg)	88 lbs (40 kg)	256 lbs (116 kg)	308 lbs (140 kg)	369 lbs (167.4 kg)	593 lbs (269 kg)
Can Ship UPS	Yes	Yes	Yes	Yes	No	No	No	No
Shipping Weight**	(UPS) 69 lbs. (31.2 kg)	(UPS) 129 lbs. (58.6 kg)	(UPS) 67 lbs (30.4 kg)	175 lbs (80 kg) or (UPS) 111 lbs (50.4 kg)	375 lbs (170 kg)	400 lbs (181 kg)	410 lbs (186 kg)	748 lbs (340 kg)
Shipping Dimensions**	UPS (in 3 boxes): (1) 25" x 25" x 7" [64 x 64 x 18 cm] (1) 19" x 17" x 7" [49 x 44 x 18 cm] (1) 13" x 13" x 7" [33 x 33 x 18 cm]	UPS (in 3 boxes): (1) 25" x 25" x 7" [64 x 64 x 18 cm] (4) 19" x 17" x 7" [49 x 44 x 18 cm] (4) 13" x 13" x 7" [33 x 33 x 18 cm]	UPS (in 2 boxes): (1) 49" x 13" x 13" [125 x 33 x 33 cm] (1) 19" x 17" x 7" [49 x 44 x 18 cm]	(1) 48" x 42" x 23" [122 x 107 x 59 cm] UPS (in 2 boxes): (1) 49" x 13" x 13" [125 x 33 x 33 cm] (1) 19" x 17" x 7" [49 x 44 x 18 cm]	(1) 48" x 45" x 30" [122 x 115 x 76 cm]	(1) 48" x 45" x 30" [122 x 115 x 76 cm]	(1) 48" x 45" x 30" [122 x 115 x 76 cm]	(1) 56" x 45" x 49" [143 x 115 x 1125 cm]

1 in = 2.54 cm
1 lb = 0.454 kg

* 25 year limited warranty. Gas springs & rubber pallet tops covered for 3 years.

** All shipping weights and dimensions are for continental US shipping only. Call for other shipping specifications. Ex-works Bethlehem, PA. Shipping weights are approximate and may vary at time of shipping.

*** Max screen width is applicable when all heads have screens loaded. Larger screens will fit when the neighboring heads are empty. **Max screen weight** is the limiting factor when all screens are not loaded.